



# FP15YPT-B

## Portrait touring yoke for FlexPoint FP15

### Features

- Portrait orientation touring yoke
- Stand mount when used with pole mount adaptor ASF20045 (available separately)
- Truss mount when used with a third-party half-coupler
- Quick deployment with no tools required.
- Central hole: 12.5 mm (0.49 in); two inner holes: 12.5 mm (0.49 in); two outer holes: 8.2 mm (0.32 in)
- Available in black

### Applications

- Touring flown FlexPoint FP15
- Touring pole mounted FlexPoint FP15

### Contents

- 1 x FP15YPT-B yoke

### Technical Specifications

Weight: 4.25 kg 9.37 lb

Material: Weatherised polyester powder coated steel

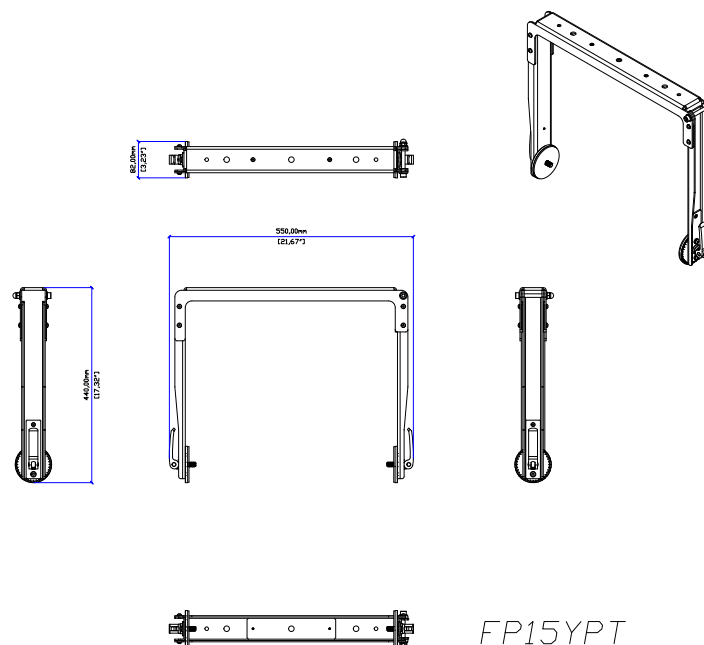

FP15YPT